

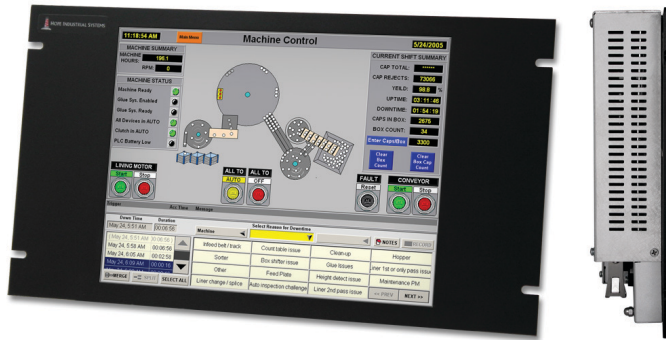

HOPE INDUSTRIAL SYSTEMS



# 15" RACK MOUNT INDUSTRIAL MONITOR REVISION G USER MANUAL

Model No. HIS-RL15- \_\_ \_ G

# Table of Contents

<b>Safety and Regulatory Information</b> .....	<b>3</b>
FCC Notice .....	3
Waste Electrical and Electronic Equipment Directive (WEEE) .....	3
<b>Mechanical Drawings</b> .....	<b>4</b>
Front View.....	4
Bottom View.....	4
Rear View .....	5
Side View.....	5
<b>Installation Instructions</b> .....	<b>6</b>
Step 1: Prepare for Installation .....	6
Step 2: Bench-test Configuration.....	7
Install Cable Connections .....	7
Install Touch Screen Driver .....	8
Step 3: Install into Rack .....	10
<b>Video Settings</b> .....	<b>11</b>
Setting the Timing Mode .....	11
Control Panel Buttons.....	12
OSD Lock Settings .....	13
On-Screen Display (OSD) Menus.....	14
<b>Cleaning Instructions</b> .....	<b>16</b>
Glass, Acrylic, and Touch Screen Window Models.....	16
No Protective Window (LCD Surface) Models.....	16
<b>Troubleshooting</b> .....	<b>17</b>
Video Troubleshooting .....	17
Touch Screen Troubleshooting .....	19
<b>Specifications</b> .....	<b>20</b>
Display .....	20
Electrical .....	20
Environmental .....	20
Video.....	21
Functional .....	21
Rack Compatibility.....	22
Physical .....	22
Compliances and Certifications .....	22
<b>Warranty Statement</b> .....	<b>23</b>



---

## Safety and Regulatory Information

---



### WARNING!

To prevent fire or shock hazard, do not expose the unit to rain or moisture. Dangerously high voltages are present inside the unit. Do not disassemble the unit. Refer servicing to qualified personnel only.

This equipment is not intended for use in critical applications where its failure to operate would create immediate life threatening circumstances. Applications including, but not limited to, nuclear reactor control, aerospace navigation systems and life support systems are not appropriate for this product.

To be covered by UL 60950 3<sup>rd</sup> Edition, the socket-outlet shall be installed near the equipment and shall be easily accessible.

---

### FCC Notice

This equipment has been tested and found to comply with the limits for a Class A digital device, pursuant to Part 15 of the FCC Rules. These limits are designed to provide reasonable protection against harmful interference when the equipment is operated in a commercial environment. This equipment generates, uses, and can radiate radio frequency energy and, if not installed and used in accordance with the instruction manual, may cause harmful interference to radio communications. Operation of this equipment in a residential area is likely to cause harmful interference in which case the user will be required to correct the interference at his own expense. Any changes or modifications not expressly approved by the grantee of this device could void the user's authority to operate the device.

### Waste Electrical and Electronic Equipment Directive (WEEE)

*The following information is only for EU-member states:*

The mark shown to the right is in compliance with the Waste Electrical and Electronic Equipment Directive 2002/96/EC (WEEE).



The mark indicates the requirement NOT to dispose of the equipment as unsorted municipal waste, but use the return and collection systems according to local law. Users should contact their supplier and check the terms and conditions of the purchase contract. When purchased directly from Hope Industrial Systems, you may contact technical support for disposal arrangements.

# Mechanical Drawings

## Front View

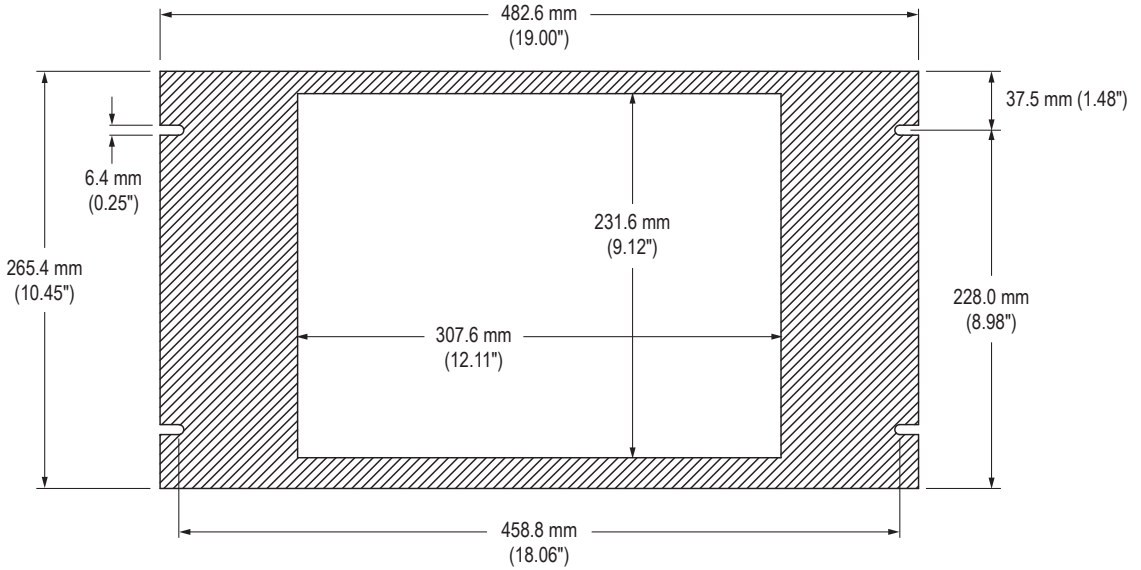

## Bottom View

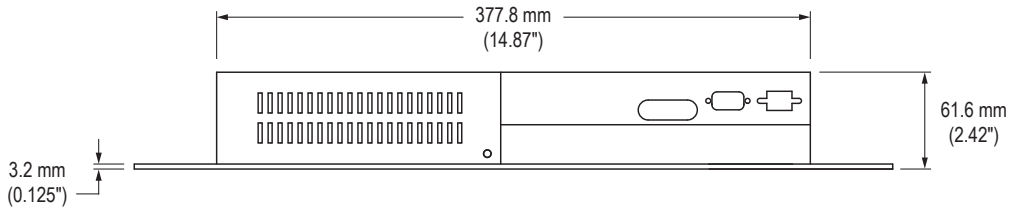

## Rear View

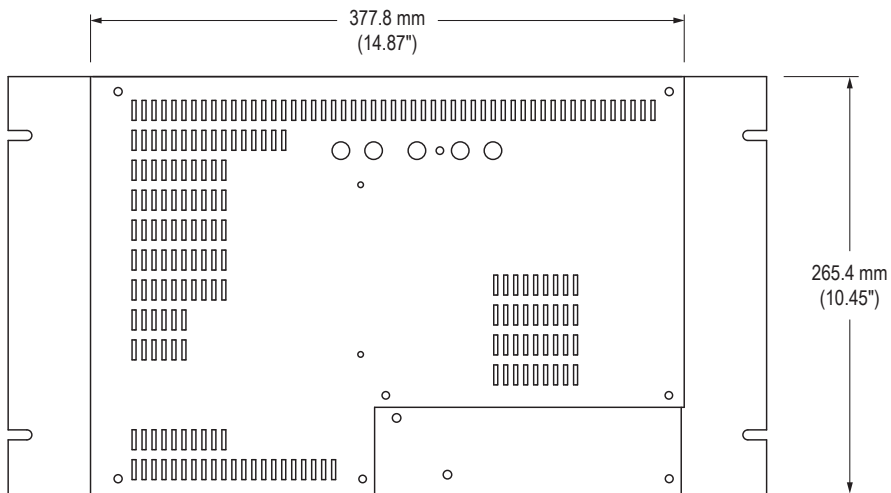

## Side View

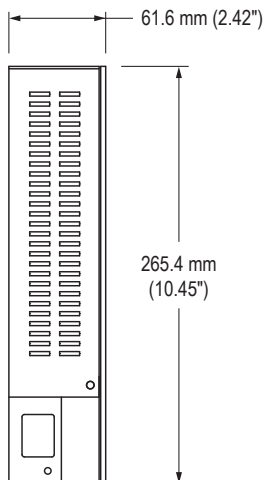

# Installation Instructions

## Step 1: Prepare for Installation

---



### IMPORTANT!

Perform the following steps **BEFORE** installation of the monitor into the rack.

---

1. Ensure that sufficient power is available.
2. Ensure that sufficient space is available to allow for proper air flow into and out of the unit.
3. Ensure that the air temperature around the unit (top and bottom) *will not exceed the rated specifications of the unit.*



- ▶ **The maximum rated temperature for the HIS-RL15 is 50°C (122°F).**
  - ▶ **Remember that heat rises – the temperature at the top of the cabinet will be much hotter than at the bottom if air inside the enclosure is not actively circulating. Even in a sealed enclosure, use of a circulation fan can greatly reduce temperature.**
  - ▶ **Also, remember that even though this product is designed to operate at 50°C, the life span of any electronic device is shortened when it is consistently operated at high temperatures. Therefore, it is wise to take steps to keep the temperature of the ambient air around the unit as low as possible.**
4. Ensure that the ambient humidity of the air around the unit *does not exceed the specifications of the unit.*
    - ▶ **The maximum rated humidity for the HIS-RL15 is 90% non-condensing.**

## Step 2: Bench-test Configuration

Make sure everything works before installing into the production environment.



**If using a KVM extender, please refer to the installation instructions included with the KVM extender module. It is particularly important to bench-test the full configuration prior to final installation. This will help to identify and troubleshoot any system issues while configuration changes may still be easily made.**

### Install Cable Connections

All monitors are shipped with both a 6 ft. (1.8 m) VGA video cable and 6 ft. (1.8 m) power cable, unless longer cables were ordered in their place. If you ordered a touch screen monitor, you also received a 6 ft. (1.8 m) USB cable and 6 ft. (1.8 m) Serial (RS-232) cable.

The cable ports are located on the rear of the monitor. Refer to the following diagram and instructions to connect power, video, and touch screen (if applicable) to your monitor.

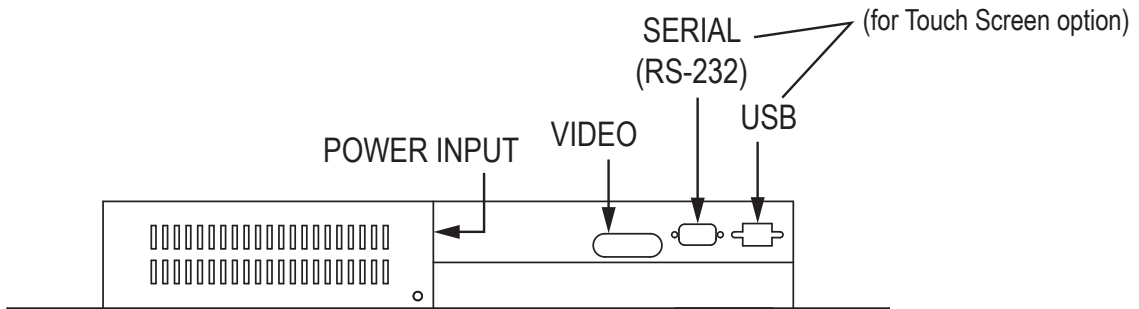

## Video Connection

The HIS-RL15 supports analog video. Connect one end of the VGA video cable to the HD-15 input port on the rear of the monitor. Connect the other end to the video output port on the host computer.

## Power Connection

The HIS-RL15 is powered by 100 to 240 VAC, 1.2/0.6 A, 60/50 Hz.

Connect the AC power cable to the power input port on the rear of the monitor. Connect the other end into a nearby outlet.

## Install Touch Screen Driver

Applies to touch screen monitors only. Instructions below apply to Windows systems. Both Serial and USB ports are present on all touch screen monitors, but only one should be used to connect the touch screen interface to the monitor.

All touch screen monitors are shipped with a CD-ROM that contains documentation and drivers for all major operating systems. To be sure that you have the most current information, please check the following Internet address:

[http://www.HopeIndustrial.com/Touchscreen\\_Drivers.htm](http://www.HopeIndustrial.com/Touchscreen_Drivers.htm)



## IMPORTANT!

**If you will be using a USB connection, *install the touch screen driver first*, and then connect the USB cable. If you will be using a Serial connection, *connect the Serial cable first*, and then install the touch screen driver.**

---

## USB Connection

1. Select the appropriate driver for your operating system.
  - a. If downloading from the web address listed above, select the appropriate driver for your operating system.
  - b. If using the included CD, insert it into the host computer's CD-ROM drive. If the CD does not automatically run, browse the contents of the CD and



open the **READ.ME.FIRST.htm** file in a web browser. Select the appropriate driver.

2. Click to "Run" the software when prompted. Follow on-screen instructions to download and execute the touch screen driver installation.
3. A cable retention bracket comes installed on the USB port on the rear of the monitor and will help to secure the cable and ensure adequate strain relief. Route one end of the USB cable through the retention bracket and connect it to the USB input port on the monitor. Connect the other end to the USB port on the host computer.

### Serial (RS-232) Connection

1. Connect one end of the Serial cable to the Serial input port on the rear of the monitor. Connect the other end to the Serial port on the host computer. Tighten the captive screws on the cable connectors to ensure adequate strain relief.
2. Select the appropriate driver for your operating system.
  - a. If downloading from the web address listed above, select the appropriate driver for your operating system.
  - b. If using the included CD, insert it into the host computer's CD-ROM drive. If the CD does not automatically run, browse the contents of the CD and open the **READ.ME.FIRST.htm** file in a web browser. Select the appropriate driver.
3. Click to "Run" the software when prompted. Follow on-screen instructions to download and execute the touch screen driver installation.

### Calibrate the Touch Screen

Once the driver has finished installing, you are ready to calibrate the touch screen. Open the touch screen's Control Panel by clicking on the "Elo Touchscreen" icon, located in the host computer's Control Panel. Under the "General" tab, click the "Align" button to start the calibration routine.



### Step 3: Install into Rack

Once you have completed the full bench-test configuration and confirmed that all components are working properly, you are ready to install the monitor into the rack.

Hope Industrial Systems' Rack Mount monitors conform to the Electronic Industries Association standard EIA-310-D. Our monitors will fit in type A, B, and C racks with a width of 482.6 mm (19") (preferred EIA rack width).

---



### WARNING!

**Hope Industrial Systems will not assume liability for damage to internal electronics due to improper installation. Contact Hope Industrial Systems if you need additional assistance.**

---

The HIS-RL15 has a panel height of 6U (shown below).

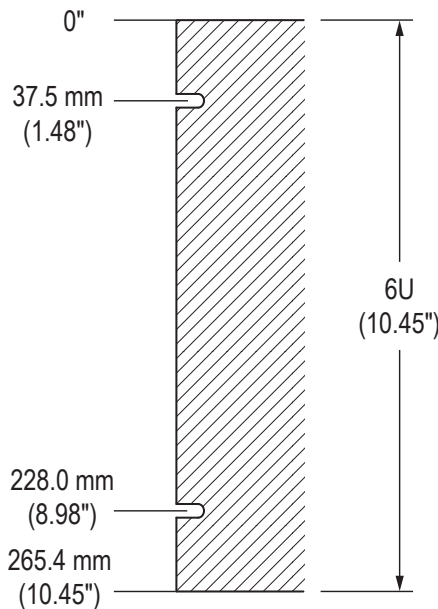

---

# Video Settings

## Setting the Timing Mode

Setting the timing mode of your computer graphics adapter (or other video source) is important for maximizing the quality of the screen image and for minimizing eye strain. The timing mode consists of the resolution (e.g. 1024 x 768) and refresh rate (or vertical frequency; e.g. 60 Hz). After setting the timing mode, use the On-Screen Display (OSD) controls to adjust the screen image.

---



### TIP!

**For the best picture quality, set your computer graphics adapter timing mode to:**

**VESA 1024 x 768 @ 60 Hz**

---

Please refer to the computer graphics adapter manufacturer's manual for instructions on setting the resolution and timing mode. In Microsoft Windows, these settings may be found at the following location:



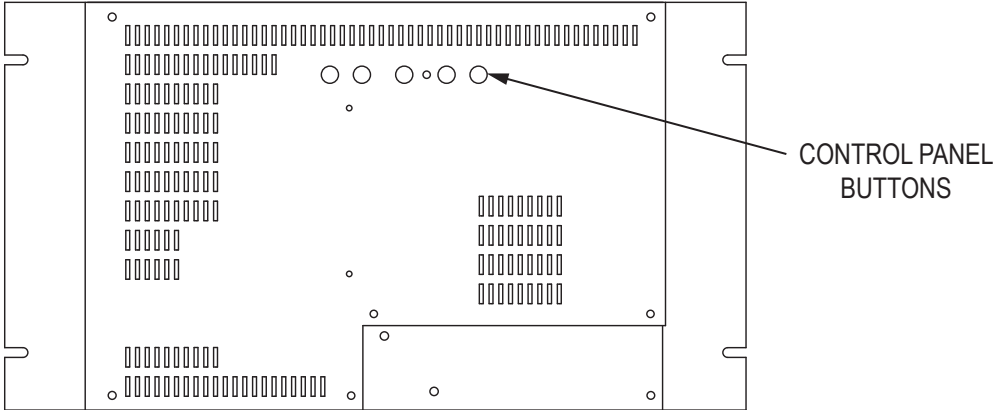

- ▶ **2000, XP:** Control Panel > Display > Settings
- ▶ **Vista:** Control Panel > Personalization > Display Settings
- ▶ **Windows 7, 8:** Control Panel > Appearance and Personalization > Adjust Screen Resolution

## Control Panel Buttons

Use the control panel buttons located on the back of the monitor to display and adjust various settings on the On-Screen Display (OSD) menu.



1. To display the Main Menu, press the left [◀] or right [▶] button.  
**NOTE:** All OSD menus and adjustments screens disappear automatically after 30 seconds.
2. To select a control to adjust, press the left [◀] or right [▶] button to scroll through the menu.
3. To adjust the control, press the minus [-] or plus [+] button.
4. To save the adjustments and return to the main OSD menu, scroll to the "Exit" function and press the minus [-] or plus [+] button.









Button	Control	Functions
	<b>Minus / Auto Adjustment</b>	When the OSD menu IS NOT displayed: <ul style="list-style-type: none"> <li>• Shortcut to Auto Adjustment.</li> </ul>
		When the OSD menu IS displayed: <ul style="list-style-type: none"> <li>• Adjusts items in the menu down.</li> </ul>
	<b>Plus</b>	Adjusts items in the menu up.
	<b>Power</b>	Turns the monitor on and off.
	<b>Power Indicator Light</b>	<ul style="list-style-type: none"> <li>• LED lit green – power is ON</li> <li>• LED not lit – power is OFF</li> <li>• LED lit orange – monitor is in Power Saving mode</li> </ul>
	<b>Menu / Left</b>	<ul style="list-style-type: none"> <li>• Opens the OSD menu.</li> <li>• Scrolls left / counterclockwise through the OSD menus.</li> </ul>
	<b>Menu / Right</b>	<ul style="list-style-type: none"> <li>• Opens the OSD menu.</li> <li>• Scrolls right / clockwise through the OSD menus.</li> </ul>







## OSD Lock Settings

- ▶ **OSD Lock:** Press and hold the minus [ – ], plus [ + ], and right [▶] buttons for 3 seconds. The message *OSD Lock Out* should appear. If any buttons are pressed the message *OSD Lock Out* will display for 20 seconds.
- ▶ **OSD Unlock:** Press and hold the minus [ – ], plus [ + ], and right [▶] buttons for 3 seconds. The message *OSD Unlocked* should appear.

## On-Screen Display (OSD) Menus

To open the OSD menu, press the left [◀] or right [▶] button once.

Menu		Description
<b>Brightness</b>		Adjusts the background black level of the screen image. 101 scales of brightness are available (0 to 100).
<b>Contrast</b>		Adjusts the difference between the background (black level) and the foreground (white level) of the screen image. 101 scales of contrast are available (0 to 100).
<b>Horizontal Position</b>		Moves the screen image left or right.
<b>Vertical Position</b>		Moves the screen image up or down.
<b>OSD Transparency</b>		Adjusts the transparency level of the OSD menu. Increasing this setting will display a more transparent OSD menu.
<b>Phase</b>		Adjusts the focus and clarity of the display. 101 scales are available (0 to 100).  <b>NOTE:</b> When troubleshooting image clarity problems, try the Auto Adjustment function first.
<b>Clock</b>		Provides a frequency tracking feature that allows the user to achieve better stability and clarity.  <b>NOTE:</b> When troubleshooting image clarity problems, try the Auto Adjustment function first.
<b>Color Temperature</b>		There are three modes to choose from: <ul style="list-style-type: none"> <li>• <b>6500K</b> adds red to the screen image for warmer white and richer red.</li> <li>• <b>7500K</b> adds blue to the screen image for cooler white.</li> <li>• <b>9300K</b> adds blue to the screen image for cooler white.</li> <li>• <b>User</b> allows individual adjustments for Red, Green, and Blue. Press the plus [ + ] button to open the User menu.</li> </ul>

Menu	Description
<b>Horizontal OSD Position</b> 	Moves the position of the OSD menu left or right.
<b>Vertical OSD Position</b> 	Moves the position of the OSD menu up or down.
<b>Graph / Text</b> 	Allows the operator to choose a display that maximizes graphics text quality. Graphics Text works in the following resolutions: <ul style="list-style-type: none"> <li>• 640 x 400 @ 56, 70 Hz</li> <li>• 720 x 400 @ 70 Hz</li> </ul> Refer to the Specifications section of this manual for a full list of supported video standards.
<b>Recall</b> 	Returns adjustments back to factory default settings.
<b>Language</b> 	Allows the user to choose the language used in the OSD menu.
<b>Auto Adjustment</b> 	Adjusts the size of the display to fill the screen. Press the plus [ + ] button to activate Auto Adjustment.
<b>Exit</b> 	Saves the settings and exits the OSD menu.

## Cleaning Instructions

---



### CAUTION!

**DO NOT USE ABRASIVE MATERIALS, SUCH AS PAPER TOWELS OR DIRTY SHOP RAGS, ON THE DISPLAY AS IT WILL SCRATCH THE PROTECTIVE COATING. ALWAYS USE A SOFT CLOTH, PREFERABLY MADE OF COTTON.**

---



### IMPORTANT!

***Always spray the cleaner on the cloth or towel first and then clean the monitor screen. Cleaner sprayed directly on the monitor could possibly leak inside a non-sealed unit and cause damage.***

---

## Glass, Acrylic, and Touch Screen Window Models

All displays with safety glass, acrylic, or resistive touch screen windows may be cleaned using any standard glass cleaner as long as there is no abrasive or oily content. Vinegar or ammonia will not hurt the screen.

The anti-reflective coatings on glass window-equipped displays are physically part of the surface of the glass and resist degradation to the Military Specifications.

To minimize over-run of cleaning solution, spray the cloth first and then clean the screen.

## No Protective Window (LCD Surface) Models

Wipe the screen with a clean, soft, lint-free cloth. This will remove dust and other particles. If the screen is still not clean, apply a small amount of non-ammonia, non-alcohol based glass cleaner onto a clean, soft, lint-free cloth, *then* wipe the screen.



# Troubleshooting

## Video Troubleshooting



### IMPORTANT!

If using a KVM extender, first try to resolve any problems using the solutions listed below. If the problem still exists, try bypassing the KVM extender. If this fixes the problem and allows the monitor to work properly, then the KVM extender is the source of the problem. Please refer to the troubleshooting section of the KVM extender manual or contact Hope Industrial Systems for additional assistance.

Symptom	Causes	Solutions
No image on the screen and control's Power Indicator light is not lit	Monitor is not powered on.	<ul style="list-style-type: none"> <li>Press the Power button on the monitor and make sure the Power Indicator light is lit green.</li> <li>Check power connections at the monitor and power source.</li> </ul>
"No Signal" message box and no image on the screen	Video cable is not plugged in correctly.	Check the video cable connection at the monitor, PC, and/or KVM extender.
	PC is in Power Saving mode.	Power Saving mode can usually be exited by moving the mouse.
	PC is not powered on.	Ensure PC is powered on.
	PC is not sending signal.	Connect the PC to another known working monitor to check the PC source signal.
No image on the screen and control's Power Indicator light is lit orange	Video cable is not plugged in correctly.	Check the video cable connection at the monitor, PC, and/or KVM extender.
	PC is in Power Saving mode.	Power Saving mode can usually be exited by moving the mouse.
	PC is not powered on.	Ensure PC is powered on.
	PC is not sending signal.	Connect the PC to another known working monitor to check the PC source signal.

Symptom	Causes	Solutions
<b>"Input Signal Out of Range" message box and no image on the screen</b>	The source signal exceeds the maximum resolution and/or refresh rate that the monitor can handle (> 1024 x 768 resolution or > 75 Hz refresh rate).	Adjust the computer settings to the monitor's native resolution: 1024 x 768 @ 60 Hz
<b>Incorrectly displayed or partial image on the screen</b>	Monitor has not been adjusted correctly for the source signal.	<ul style="list-style-type: none"> <li>• Activate the "Auto Adjustment" function in the OSD menu. This feature may also be activated by pressing the minus [ - ] button outside of the OSD menu.</li> <li>• Fine tune the picture by manually adjusting the image using the settings in the OSD menu.</li> </ul>
<b>Wrong or abnormal colors (white is not white)</b>	Monitor color settings are incorrectly adjusted.	Reset the monitor to the factory default settings by activating the "Recall" function in the OSD menu.
	Video cable is not securely connected.	If any colors (red, green, or blue) are missing, check the video cable to make sure it is securely connected.
	Video cable is bad.	Check to make sure there are no loose or broken pins in the cable connector. Shorts in the cable could also cause an improper image to display.
<b>Screen image is dim</b>	Brightness and/or contrast settings are not set properly.	Adjust the monitor's brightness and/or contrast settings in the OSD's "Contrast" and "Brightness" menus.
<b>The message "OSD Lock Out" appears</b>	The OSD has been locked to prevent unauthorized shut down of the monitor.	Press and hold the minus [ - ], plus [ + ], and right [ ► ] buttons for 3 seconds.



## Touch Screen Troubleshooting

Applies to touch screen monitors only. To be sure that you have the most current driver, please check the following Internet address:

[http://www.HopeIndustrial.com/Touchscreen\\_Drivers.htm](http://www.HopeIndustrial.com/Touchscreen_Drivers.htm)

Symptom	Causes	Solutions
<b>No response when touching the touch screen</b>	Touch screen driver has not been installed.	Download and install the latest driver from the Hope Industrial website.
	Touch screen cable is not plugged in correctly.	Make sure either the USB or Serial cable is securely connected to the monitor and PC. Do not connect both.
	If using a USB connection, does the USB cable length exceed 3 meters?	USB cables have a 3 meter limitation and could cause no touch response if this is exceeded.
	If using a Serial connection, is the Serial cable plugged into the correct COM port?	Ensure that the Serial cable is connected to the COM port being used prior to installing the touch screen driver.
<b>The cursor moves but does not follow my finger when touching the touch screen</b>	Touch screen driver has not been installed.	Download and install the latest driver from the Hope Industrial website.
	Touch screen has not been calibrated.	<p>Activate the calibration utility. In Windows systems, these settings may be found at the following location:</p> <p>Control Panel &gt; Elo Touchscreen &gt; "General" Tab</p> <ul style="list-style-type: none"> <li>• Press the Align button.</li> <li>• Touch all targets as the appear to calibrate the touch screen.</li> <li>• Press the Green Check button when verified.</li> </ul>

# Specifications

Display	
Type	Thin-film transistor (TFT) Active Matrix Liquid Crystal
Size	15" diagonal
Image Size (W x H)	304 mm x 228 mm (12.0" x 9.0")
Native Resolution	XGA (1024 x 768, 4:3 aspect ratio)
Minimum Resolution	VGA (640 x 350)
Pixel Pitch	0.297 mm x 0.297 mm
Number of Colors	262,144; 16.2 million with FRC or Dithering
Brightness (white)	250 nits (cd/m <sup>2</sup> )
Viewing Angle (Hori/Vert)	140° / 120°
Contrast Ratio (typical)	500:1
Backlight	2 CCFTs (Cold Cathode Fluorescent Tube); 50,000 hour brightness half-life

Electrical	
Monitor Input	100 to 240 VAC, 1.2/0.6 A, 60/50 Hz
Power Consumption	~ 25 W
Power Consumption (Standby mode)	DPMS, < 2 W

Environmental	
Temperature	0° to 50°C (32° to 122°F)
Humidity	20% to 90% non-condensing
Operating Shock	15 g, 6 msec, half-sine
Operating Vibration (sine)	1.0g, swept sine 9 – 500 Hz
Transport Vibration (random)	0.1g <sup>2</sup> / Hz, 10 – 200 Hz 0.03g <sup>2</sup> / Hz, 200 – 2000 Hz
Altitude	<ul style="list-style-type: none"> <li>Operating: up to 10,000 feet</li> <li>Non-operating: up to 40,000 feet</li> </ul>

Video	
<b>Input Connectors</b>	<ul style="list-style-type: none"> <li>• HD-15</li> <li>• Optional BNC input using HD-15 to 5-wire BNC adapter; see "Input Signal Formats" for a list of compatible video signals.</li> <li>• Optional DisplayPort input using DisplayPort to VGA adapter.</li> </ul>
<b>Input Signal Formats</b>	RGB Analog video, 0.7 Vp-p, 75 Ohms Compatible sync modes: Separate H/V sync <b>NOTE:</b> NTSC/PAL composite input available (call for details)
<b>Horizontal Scan</b>	24 – 61 kHz
<b>Vertical Scan</b>	56 – 75 Hz
<b>Supported Video Standards</b>	<ul style="list-style-type: none"> <li>• 1024 x 768 @ 60, 66, 70, 75 Hz</li> <li>• 800 x 600 @ 56, 60, 72, 75 Hz</li> <li>• 720 x 400 @ 70 Hz</li> <li>• 640 x 480 @ 60, 72, 75 Hz</li> <li>• 640 x 400 @ 56, 70 Hz</li> <li>• 640 x 350 @ 70 Hz</li> </ul>
<b>Response Rate (typical)</b>	12 ms

Functional	
<b>Control Panel Buttons</b>	– (Minus / Auto Adjustment), + (Plus), Power, Menu / Left, Menu / Right
<b>On-Screen Display (OSD) Menus</b>	Brightness, Contrast, Horizontal Position, Vertical Position, OSD Transparency, Phase, Clock, Color Temperature, Horizontal OSD Position, Vertical OSD Position, Graph / Text, Recall, Language, Auto Adjustment, Exit
<b>Touch Screen Option</b>	5-wire resistive system; emulates a mouse; Serial (RS-232) and USB interface to host computer

<b>Rack Compatibility</b>	
<b>EIA Standard</b>	EIA-310-D
<b>EIA Type Rack</b>	A, B, and C
<b>Rack Width</b>	482.6 mm (19.0") (preferred EIA width)
<b>Mounting</b>	4 Slots, 6.4 mm (0.25") wide
<b>Panel Height</b>	6U, 265.4 mm (10.45")

<b>Physical</b>	
<b>Enclosure Type</b>	Rack mount
<b>Panel Rating</b>	Built to IP20 standards; NEMA/UL Type 1
<b>Bezel Finish</b>	Black Powder-Coated Carbon Steel, matte finish
<b>Depth Behind Bezel</b>	58.4 mm (2.3")
<b>Front Bezel Outside Dimensions (W x H x D)</b>	482.6 mm x 265.4 mm x 3.2 mm (19.0" x 10.45" x 0.125")
<b>Net Weight</b>	11 lbs.
<b>Shipping Weight</b>	15 lbs.

<b>Compliances and Certifications</b>	
<b>Electrical</b>	<ul style="list-style-type: none"> <li>• UL 60950 3<sup>rd</sup> Edition / cUL Recognized Component (File No. E212889)</li> <li>• UL 508A Listed (File No. E318630)</li> <li>• FCC Class A</li> <li>• CAN ICES-3A/NMB-3A</li> <li>• CE</li> </ul>
<b>Environmental</b>	<ul style="list-style-type: none"> <li>• IEC 60721-3 (Reliability)</li> <li>• WEEE (Registration No. WEE/DJ1859ZX for UK only)</li> </ul>
<b>Enclosure</b>	UL 50E (File No. E318630)

---

# Warranty Statement

## **Who is Covered?**

This warranty covers the purchaser of this product only and is not transferable without our written consent.

## **What Does This Warranty Cover and What is the Period of Coverage?**

We warrant this product to be free from defects in material and workmanship, subject to the conditions set forth below. The warranty on all industrial display products, KB-R2 and KB-M2 keyboard series, KVM2 extender series, and ENCL-TC and ENCL-PC enclosure series remains in force for a three year period beginning on the date we invoice you. The warranty period on KB-PL1 keyboards is two years, and all other keyboards carry a one year warranty. If Hope Industrial Systems repairs or replaces a product under warranty, its warranty term is not extended.

## **What Will We Do to Correct Problems and How Do You Get Service?**

We will repair or replace (at our sole option) any part of the unit which proves to be defective. Replacement parts may be new or refurbished and will meet the same specifications of the original parts or unit. For orders sold through our U.S. operations, at our expense we will return the product to any location within the U.S.A. via the shipping method of our choice. Shipping fees for products returned to customers outside the U.S.A. are the responsibility of the customer. For products originally sold through Hope Industrial U.K., return shipping to and from Hope Industrial repair facilities and any EU member country (except Croatia, Cyprus, and Malta) will be provided using a pre-paid UPS shipping label sent via email. In order to receive warranty service you must get prior approval from Hope Industrial Systems. To request warranty service you can telephone us at +1 678 762 9790 or +44 (0) 20 7193 2618 in the United Kingdom or send an email to support@HopeIndustrial.com. If we determine that warranty service is needed we will give you a Return Material Authorization (RMA) number. This RMA number must be conspicuously marked on the outside of the shipping box. Hope Industrial Systems will not accept shipments not accompanied by the RMA number. Except where otherwise noted, you must ship or deliver the product to Hope Industrial Systems Freight prepaid.

## **What Does This Warranty Not Cover?**

This warranty does not cover equipment which has been damaged due to misuse, abuse, or accident such as: operating the equipment outside of published specifications; exposure to chemicals or gases not covered by specified NEMA standards; displaying fixed images for long periods of time resulting in afterimage effects; improper or unauthorized repair by anyone other than Hope Industrial Systems or a service agency authorized by Hope Industrial Systems to perform such repairs; fire, flood, "acts of God", or other contingencies beyond the control of Hope Industrial Systems.

Hope Industrial Systems' responsibility for malfunctions and defects in hardware is limited to repair and replacement as set forth in this warranty statement. Hope Industrial Systems shall not be liable for direct, indirect, incidental, consequential, or other types of damages resulting from the use of any Hope Industrial Systems product other than the liability stated above. These warranties are in lieu of all other warranties express or implied, including, but not limited to, the implied warranties of merchantability or fitness for a particular purpose. Some states do not allow the exclusion of implied warranties or the limitation or exclusion of liability for incidental or consequential damages so the above exclusions or limitations may not apply to you. You are cautioned that the performance of this product can be affected by many factors, such as system configuration, software, application, and operator control of the system. It is your responsibility to determine suitability of this product for your purpose and application.

# Hope Industrial Systems, Inc.

## US / International

1325 Northmeadow Parkway  
Suite 100  
Roswell, GA 30076  
United States

Toll Free: (877) 762-9790  
International: +1 (678) 762-9790  
Fax: +1 (678) 762-9789

**Sales and Customer Service:** [sales@HopeIndustrial.com](mailto:sales@HopeIndustrial.com)  
**Support and Returns:** [support@HopeIndustrial.com](mailto:support@HopeIndustrial.com)  
**Accounting Department:** [accounting@HopeIndustrial.com](mailto:accounting@HopeIndustrial.com)  
[www.HopeIndustrial.com](http://www.HopeIndustrial.com)

## United Kingdom

Harling Road  
Snetterton  
Norwich  
NR16 2JU  
United Kingdom

Phone: +44 (0) 20 7193 2618  
Fax: +44 (0) 20 7117 1194

**Sales and Customer Service:** [sales@HopeIndustrial.co.uk](mailto:sales@HopeIndustrial.co.uk)  
**Support and Returns:** [support@HopeIndustrial.co.uk](mailto:support@HopeIndustrial.co.uk)  
**Accounting Department:** [accounting@HopeIndustrial.co.uk](mailto:accounting@HopeIndustrial.co.uk)  
[www.HopeIndustrial.co.uk](http://www.HopeIndustrial.co.uk)

