

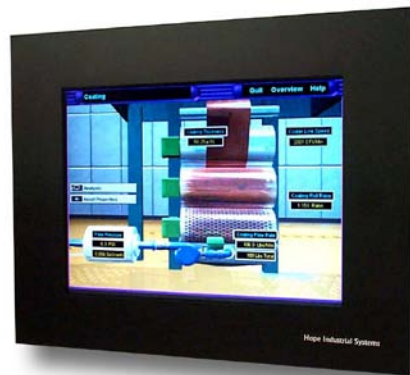

# *User Manual*

## 19" Panel Mount Industrial Monitor

Model No. HIS-ML19-\_\_ \_C



## **TABLE OF CONTENTS**

<b>Safety and Regulatory Information .....</b>	<b>3</b>
Warning .....	3
FCC Notice .....	3
<b>Using the LCD Display .....</b>	<b>4</b>
Setting the Timing Mode .....	4
OSD and Power Lock Settings .....	4
<b>Adjusting the Screen Image.....</b>	<b>5</b>
<b>Main Menu Controls .....</b>	<b>6</b>
<b>Installation Instructions .....</b>	<b>9</b>
Preparing for Installation .....	9
Installation into Panel.....	10
<b>Touchscreen Driver Installation .....</b>	<b>11</b>
<b>Cleaning.....</b>	<b>12</b>
Resistive Touchscreen model.....	12
Tempered Anti-Reflective Glass Window .....	12
Acrylic Window.....	12
<b>Troubleshooting .....</b>	<b>13</b>
<b>Drawings.....</b>	<b>14</b>
<b>Specifications.....</b>	<b>16</b>
Compliance .....	17
<b>Warranty Statement.....</b>	<b>19</b>

# Safety and Regulatory Information

## Warning

**To prevent fire or shock hazard, do not expose the unit to rain or moisture. Dangerously high voltages are present inside the unit. Do not disassemble the unit. Refer servicing to qualified personnel only.**

**This equipment is not intended for use in critical applications where its failure to operate would create immediate life threatening circumstances. Applications including, but not limited to, nuclear reactor control, aerospace navigation systems and life support systems are not appropriate for this product.**

**This product is intended to be mounted in a suitable cabinet or other enclosure. NEMA 4, 4x or 12 ratings are applicable only when properly installed in a like rated enclosure.**

**This product is a UL Recognized Component and must be used with a listed computer.**

## FCC Notice

This equipment has been tested and found to comply with the limits for a Class A digital device, pursuant to Part 15 of the FCC Rules. These limits are designed to provide reasonable protection against harmful interference when the equipment is operated in a commercial environment. This equipment generates, uses, and can radiate radio frequency energy and, if not installed and used in accordance with the instruction manual, may cause harmful interference to radio communications. Operation of this equipment in a residential area is likely to cause harmful interference in which case the user will be required to correct the interference at his own expense. Any changes or modifications not expressly approved by the grantee of this device could void the user's authority to operate the device.

# Using the LCD Display

## Setting the Timing Mode

Setting the timing mode is important for maximizing the quality of the screen image and minimizing eye strain. The timing mode consists of the resolution (example 1280 x 1024) and refresh rate (or vertical frequency; example 60 Hz). After setting the timing mode, use the controls to adjust the screen image.

For the best picture quality set your LCD display timing mode to: VESA 1280 x 1024 @ 60Hz.

To set the Timing Mode in Microsoft Windows:

1. **Set the resolution:** Right-click on the Windows desktop > Properties > Settings > set the resolution.
2. **Set the refresh rate:** See your graphic card's user guide for instructions.

**WARNING:** Do not set the graphics card in your computer to exceed the maximum refresh rate of 85Hz; doing so may result in permanent damage to your LCD display.

## OSD and Power Lock Settings

- **OSD Lock:** Press and hold [1] and the up arrow for 10 seconds. If any buttons are pressed the message *OSD Locked* will display for a few seconds.
- **OSD Unlock:** Press and hold [1] and the up arrow again for 10 seconds.
- **Power Button Lock:** Press and hold [1] and the down arrow for 10 seconds. If the power button is pressed the message Power Button Locked will display for 5 seconds. With or without this setting, after a power failure, your LCD display's power will automatically turn ON when power is restored.
- **Power Button Unlock:** Press and hold [1] and the down arrow again for 10 seconds.

# Adjusting the Screen Image

Use the buttons on the rear control panel to display and adjust the On-Screen Display (OSD) controls which display on the screen. Do the following to adjust the screen image:

1. To display the Main Menu, press button [1].

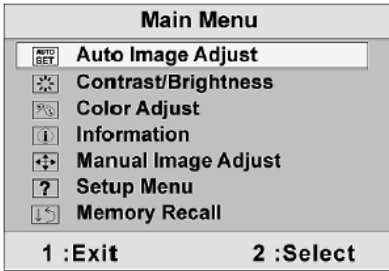

**NOTE:** All OSD menus and adjustment screens disappear automatically after about 15 seconds.

2. To select a control you want to adjust, press ▲ or ▼ to scroll up or down the Main Menu.
3. After the control is selected, press button [2]. A control screen like the one shown below appears.

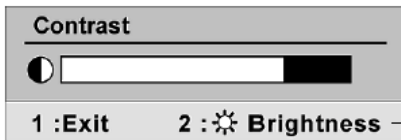

The line at the bottom of the screen shows the current functions of buttons 1 and 2: Exit or select the Brightness control.



4. To adjust the control, press the up ▲ or ▼ buttons.
5. To save the adjustments and exit the menu, press button [1] twice



**The following tips may help you optimize your display:**



- Adjust your computer's graphic card so that it outputs a video signal 1280 x 1024 @ 60 Hz to the LCD display. (Look for instructions on "changing the refresh rate" in your graphic card's user guide.)
- If necessary, make small adjustments using H POSITION and V POSITION until the screen image is completely visible. (The black border around the edge of the screen should barely touch the illuminated "active area" of the LCD display.)

# Main Menu Controls

Adjust the menu items shown below by using the up ▲ and down ▼ buttons.

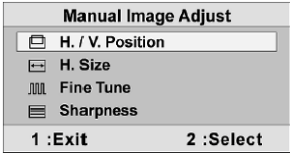
Control	Explanation
	<p><b>Auto Image Adjust</b> automatically sizes, centers, and fine tunes the video signal to eliminate waviness and distortion. Press the [2] button to obtain a sharper image.</p> <p><b>NOTE:</b> Auto Image Adjust works with most common video cards. If this function does not work on your LCD display, then lower the video refresh rate to 60 Hz and set the resolution to its pre-set value.</p>
	<p><b>Contrast</b> adjusts the difference between the image background (black level) and the foreground (white level).</p> <p><b>Brightness</b> adjusts background black level of the screen image.</p>
	<p><b>Color Adjust</b> provides several color adjustment modes: preset color temperatures and RGB which allows you to adjust red (R), green (G), and blue (B) separately. The factory setting for this product is 6500K (6500 Kelvin).</p> <div data-bbox="270 812 585 997" style="border: 1px solid gray; padding: 5px; margin: 10px 0;"> <p style="text-align: center;">Color Adjust</p> <p>sRGB 9300K • 6500K 5400K User Color</p> <p>1 :Exit                      2 :Select</p> </div> <ul style="list-style-type: none"> <li>○ <b>sRGB</b> – This is quickly becoming the industry standard for color management, with support included in many of the latest applications. Enabling this setting allows the LCD display to more accurately display colors the way they were originally intended. Enabling the sRGB setting will cause the Contrast and Brightness adjustments to be disabled.</li> <li>○ <b>9300K</b> – Adds blue to the screen image for cooler white (used in most office settings with fluorescent lighting).</li> <li>○ <b>6500K</b> – Adds red to the screen image for warmer white and richer red.</li> <li>○ <b>5400K</b> - Adds green to the screen image for a darker color.</li> <li>○ <b>User Color</b> – Individual adjustments for red (R), green (G), and blue (B).             <ul style="list-style-type: none"> <li>○ To select color (R, G or B) press button [2]</li> <li>○ To adjust selected color, press ▲ or down ▼</li> </ul> </li> </ul>

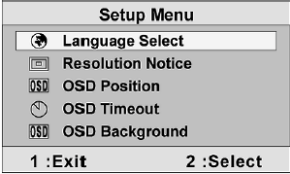
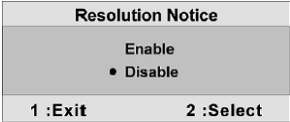
Control	Explanation
	<p><b>Information</b> displays the timing mode (video signal input) coming from the graphics card in the computer.</p> <p>See your graphics card's user guide for instructions on changing the resolution and refresh rate (vertical frequency).</p>
	<p><b>Manual Image Adjust</b> displays the Manual Image Adjust menu.</p>  <ul style="list-style-type: none"> <li>○ <b>H./V. Position</b> moves the screen image left or right and up or down. Press button [2] to toggle between Horizontal and Vertical. The Horizontal setting moves the screen image to the left or to the right. The Vertical setting moves the screen image up and down.</li> <li>○ <b>H. Size</b> adjusts the width of the screen image.</li> <li>○ <b>Fine Tune</b> sharpens the focus by aligning text and/or graphics with pixel boundaries.</li> </ul> <p style="text-align: center;"><b>NOTE:</b> Try the Auto Adjust function before using the Fine Tune control.</p> <ul style="list-style-type: none"> <li>○ <b>Sharpness</b> adjusts the clarity and focus of the screen image.</li> </ul>

Control	Explanation
	<p><b>Setup Menu</b> displays the menu shown below.</p>  <ul style="list-style-type: none"> <li>○ <b>Language</b> allows you to choose the language used in the menus and control screens.</li> <li>○ <b>Resolution Notice</b> advises of the optimal resolution to use.</li> </ul>  <ul style="list-style-type: none"> <li>○ <b>OSD Position</b> allows you to move the on-screen display menus and control screens</li> <li>○ <b>OSD Timeout</b> sets the length of time an on-screen display screen is displayed. For example, with a “15 second” setting, if a control is not pushed within 15 seconds, the display screen disappears.</li> <li>○ <b>OSD Background</b> allows you to turn the On-Screen-Display background on or off.</li> </ul>
	<p><b>Memory Recall</b> returns adjustments to the original factory settings if the display is operating in a factory Preset Timing Mode listed in this user guide.</p>



# Installation Instructions

## Preparing for Installation

**Important!** Perform the following steps **BEFORE** Installation of the monitor into the panel.

1. Ensure that sufficient power is available.
2. Ensure that sufficient space is available to allow for proper airflow into and out of the unit.
3. Ensure that the air temperature around the unit (top and bottom) will not exceed the rated specifications of the unit.
  - **The maximum rated temperature of the HIS-ML19 is 45°C (113°F) when properly ventilated with moving air across the back of the unit– consult the factory for installation instructions when continuous 24/7 operation exceeds 40°C (104°F).**
  - ***Remember that heat rises – the temperature at the top of the cabinet will be much hotter than at the bottom when the air is not circulating.***
  - ***Also, remember that even though this product is designed to operate at 45°C with proper ventilation, the life span of any electronic device is shortened when it is consistently operated at high temperatures. Therefore it is wise to take steps to keep the temperature of the ambient air around the unit as low as possible.***
4. Ensure that the ambient humidity of the air around the unit does not exceed the rated specifications for the unit
  - ***The maximum rated humidity for the HIS-ML19 is 90% non-condensing***

## Installation into Panel

1. Refer to the drawing below.
2. Locate position in panel for mounting of the monitor. Assure that there is adequate space begin the panel. Allow extra space (0.5 in. behind and on each side) for air ventilation.
3. Cut a rectangular hole in the panel. Clean and deburr. Dimensions: 17.85" (454mm) W x 14.44" (367mm) H ; +/- .020"
4. Separate the rear collar from the unit by removing the 12 nuts.
5. Insert the unit into the front of the panel and re-attach the collar.
6. Tighten all 12 nuts to a torque of 24 inch-pounds to assure a water-tight seal between the poron bezel gasket on the monitor and equipment panel. *HIS will not assume liability for damage to internal electronics due to improper installation.*

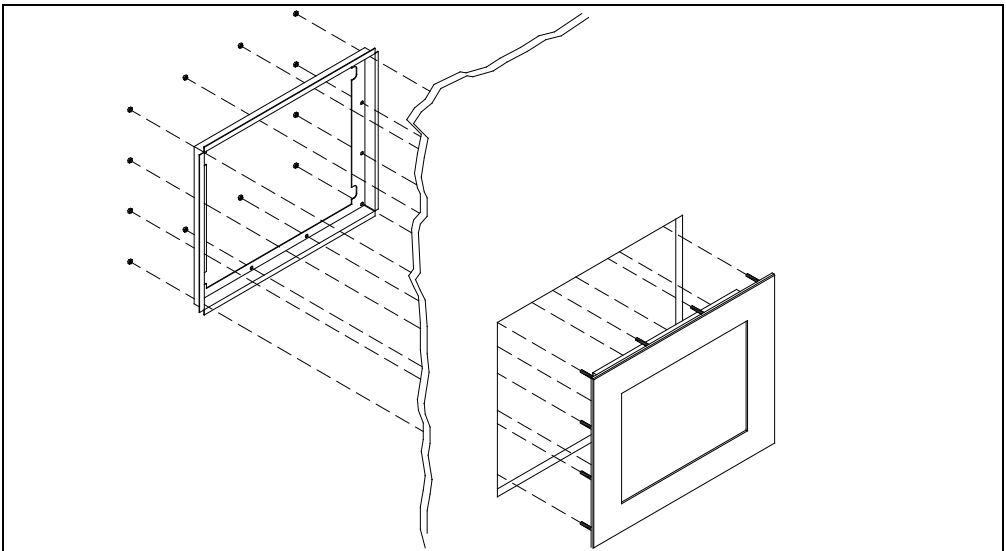

# Touchscreen Driver Installation

The enclosed CD-ROM contains documentation and drivers for all major operating systems. To assure you have the most current information, check the following Internet addresses:

[http://HISmonitors.com/Touchscreen\\_Drivers.htm](http://HISmonitors.com/Touchscreen_Drivers.htm)

# Cleaning

## **Resistive Touchscreen model**

Any standard glass cleaner can be used to clean the touchscreen. Always spray the glass cleaner on the cloth or towel and then clean the touchscreen. Glass cleaner sprayed directly on the monitor could possibly leak inside a non-sealed unit and cause damage. Vinegar or ammonia will not hurt the touchscreen. Again, spray the cloth and then clean the touchscreen.

## **Tempered Anti-Reflective Glass Window**

Use any standard glass cleaner as long as there is no abrasive or oily content. The anti-reflective coatings are physically part of the surface of the glass and resist degradation to the Military Specifications.

## **Acrylic Window**

The acrylic front window can be cleaned in the same manner as the touchscreen or glass window.

# Troubleshooting

## Blank Screen

After installing the power cable and connecting video cable to a PC, the monitor displays a blank screen.

- Press the power button and check to see if the power LED is lit.
- If the LED is not lit, make sure the PC is powered on. Make sure all cables are connected.
- If the LED stays yellow, check to see if the PC is in the power saving mode by pressing any keys on the keyboard.

## Rolling Screen

- Change PC display resolution to 1280x1024 at 60hz.
- Unplug the power cable to monitor, then plug it in again.
- Press monitor power button again.
- Reset the monitor to the original factory setting.
- Press “Auto Adjust” button on OSD menu.

## Unstable Screen

- Select “Auto Adjust”.
- Make sure the PC display resolution is not set greater than 1280x1024 at 60hz.
- Make sure the PC display resolution matches one of the factory-preset timings in this manual.
- Change the PC display resolution to 1280x1024 at 60hz.
- Reset the monitor to the factory setting.
- Select “Auto Adjust”.

## Screen is not perfect

- Make sure the PC display resolution matches one the factory preset timings shown in this manual.
- Recall factory setting. Refer to panel controls and OSD functions in this manual.
- Fine-tune the picture by performing the following adjustments in this order – pitch, phase, and position. Refer to OSD functions in this manual.

# Drawings

## Front View

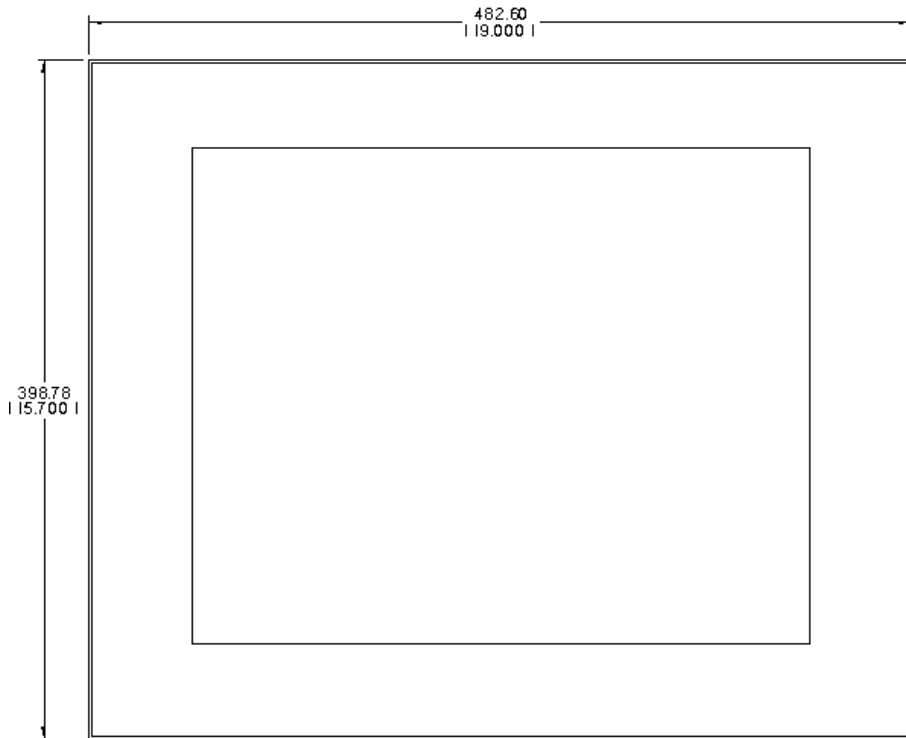

## Bottom and Rear View (showing cutout dimensions)

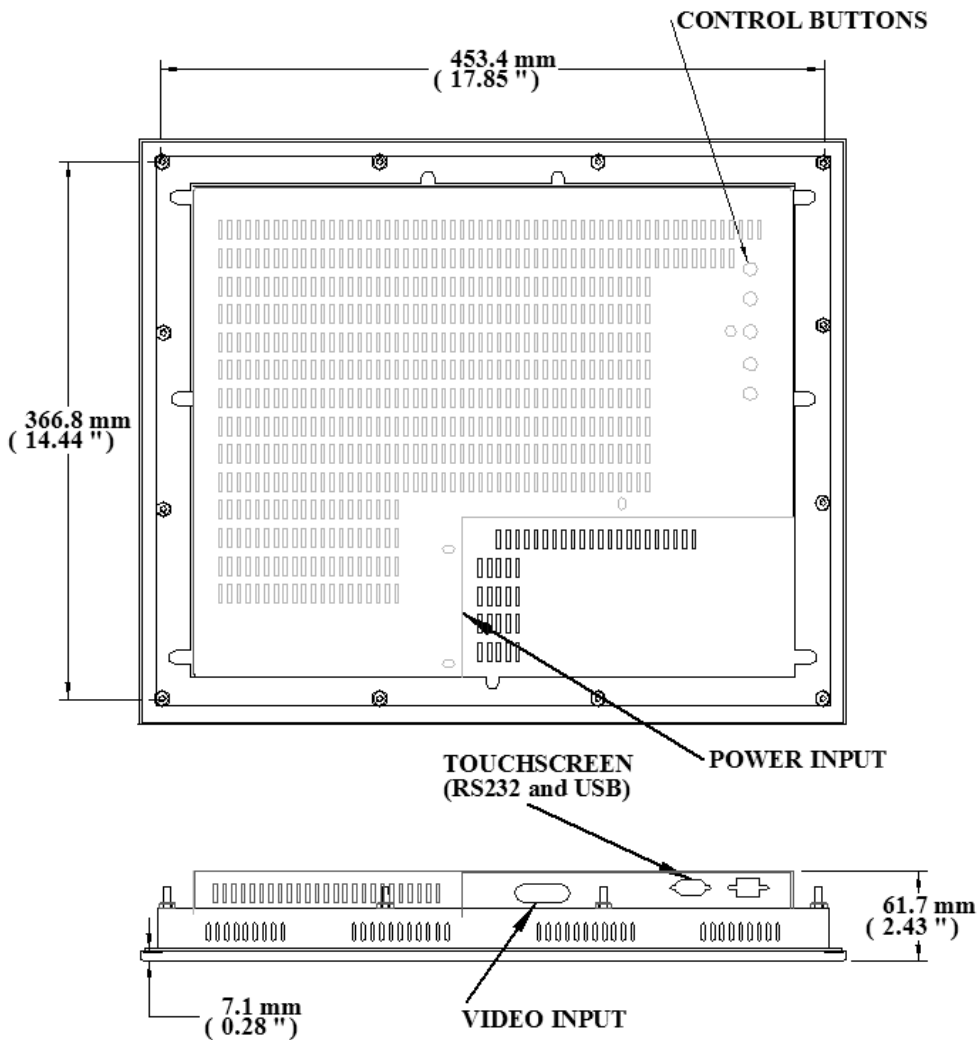

# Specifications

## Display

Type	Thin-film transistor (TFT) Active Matrix Liquid Crystal
Size	19.0" diagonal
Image size	14.8" (376mm) x 11.9" (301mm)
Native resolution	SXGA (1280 x 1024) @ 60 Hz
Plug and Play	DDC1/2B compatible
Minimum resolution	VGA (640 x 480), operation in native resolution (1280 x 1024) will ensure best results
Pixel pitch	0.294mm (H) x 0.294 mm (V)
Number of colors	16M (24 bit)
Viewing Angle (Hori/Vert)	160° / 160°, typical
Brightness (white)	300 nits (cd/m <sup>2</sup> ) min
Contrast ratio	700:1 min.
Back light	4 CCFTs (Cold Cathode Fluorescent Tube); 50,000 hours, half-life; replaceable
Screen protector (when not shipped with touch-screen)	Tempered glass to ANSI-Z97.1 SPEC; AR coated on both sides; 98% Transmission of light; 99% Reduction of glare; 53% UV blocking; 30% NIR Blocking; proprietary hydrophobic coating on outside reduces fingerprint smears, repels liquid spills and makes glass easy to clean.

## Video

Input connector	HD-15
Input signal format	Analog RGB signals, 0.7 Vp-p, Separate H/V Sync
Horizontal scan	30kHz – 82kHz
Vertical scan	50 Hz – 85 Hz
Supported Video Standards	1280 x 1024 @ 60, 75 Hz 1024 x 768 @ 60, 70, 72, 75 Hz 800 x 600 @ 56, 60, 72, 75 Hz 640 x 480 @ 60, 75 Hz 720 x 400 @ 70 Hz
Response rate (typical)	8 ms, typical



## Electrical

Power Input	100–240 VAC, 50-60 Hz (autoswitch)
Power consumption	33 watts, typical
Power management	DPMS/energy star, < 1W

## Environmental

Temperature	0-45°C (consult factory for installation instructions when continuous 24/7 operation exceeds 40°C)
Humidity	20% to 90% non-condensing
Shock	30g (1/2 sine, 11 msec.)
Vibration	0.006 inch p-p 15-57Hz, 1.0g 57-640Hz sine
Altitude	Operating: up to 10,000 feet; Non-operating: up to 40,000 feet

## Functional

Panel controls (rear access)	Power (soft), 1, DOWN, UP, 2
OSD (On Screen Display) controls	Auto image adjust, brightness, contrast, input selection, color adjust (sRGB, 9300K, 6500K, 5400K), information, manual image adjust (H. position, V. position, fine tune, sharpness), language, resolution notice, OSD position, OSD timeout, OSD background, memory recall
Touch screen option	Elo Touch systems AccuTouch 5-wire resistive system; emulates a mouse; Serial RS-232 or USB interface to host computer
Rack mount option	Fits in standard 19" EIA rack, 9U height

## Compliance

Electrical	UL 60950 3 <sup>rd</sup> Edition, cUL recognized component; FCC Class A; CE
Environmental	RoHS

## Enclosure

Type	Panel mount; rear collar compresses gasket against panel, held by 12 M5 studs
Panel rating	NEMA 12/4/4X (with proper installation) – built to IP65 standards

## Physical

Depth	2.15" (54.6 mm) behind panel maximum
Bezel	Powder Coated Carbon steel, black or Stainless Steel
Front bezel outside dimensions	19.0" (483mm) W x 15.7" (399mm) H x 0.236" (6mm) thick (not including gasket)
Cutout dimensions	17.85" (454mm) W x 14.44" (367mm) H ; +/- .020"
Net weight	Black Carbon Steel Model – 18.15 lbs. Stainless Steel Model – 17.85 lbs.
Shipping weight	23 lbs.

## VGA Pin assignment

Pin No.	Signal	Pin No.	Signal
1	Red	9	No pin
2	Green	10	Ground
3	Blue	11	Ground
4	Ground	12	SDA
5	Ground	13	H. sync
6	Ground	14	V. sync
7	Ground	15	SCL
8	Ground		

# Warranty Statement

## **Who is Covered?**

This warranty covers the purchaser of this product only and is not transferable without our written consent.

## **What Does This Warranty Cover and What is the Period of Coverage?**

The warranty remains in force for a three year period beginning on the date we invoice you for the product unless it is a keyboard, for which the warranty period is one year. If HIS repairs or replaces a product under warranty, its warranty term is not extended.

## **What Will We Do to Correct Problems and How Do You Get Service?**

We will repair or replace (at our sole option) any part of the unit which proves to be defective. Replacement parts may be new or refurbished and will meet the same specifications of the original parts or unit. We will return the product to you, by the shipping method we choose in the U.S.A. at our expense. You must pay for shipments to locations outside of the U.S.A. In order to receive warranty service you must get prior approval from HIS. To request warranty service you can telephone us at 678-762-9790 or send an email to service@HISmonitors.com. If we determine that warranty service is needed we will give you a Return Material Authorization (RMA) number. This RMA number must be conspicuously marked on the outside of the shipping box. HIS will not accept shipments not accompanied by the RMA number. You must ship or deliver the product to HIS Freight prepaid.

## **Pixel Faults**

Permanently dark or bright pixels can happen to TFT displays. Five or less permanently dead pixels (out of 1.3 million) do not make a good case for exchanging the unit. Please contact our Customer Service Department if the number of pixel faults exceeds the above-mentioned figure.

## **What Does This Warranty Not Cover?**

This warranty does not cover equipment which has been damaged due to misuse, abuse or accident such as: operating the equipment outside of published specifications; exposure to chemicals or gasses not covered by specified NEMA standards; displaying fixed images for long periods of time resulting in afterimage effects; improper or unauthorized repair by anyone other than HIS or a service agency authorized by HIS to perform such repairs; fire, flood, "acts of God", or other contingencies beyond the control of HIS.

HIS' RESPONSIBILITY FOR MALFUNCTIONS AND DEFECTS IN HARDWARE IS LIMITED TO REPAIR AND REPLACEMENT AS SET FORTH IN THIS WARRANTY STATEMENT. HIS SHALL NOT BE LIABLE FOR DIRECT, INDIRECT, INCIDENTAL, CONSEQUENTIAL, OR OTHER TYPES OF DAMAGES RESULTING FROM THE USE OF ANY HIS PRODUCT OTHER THAN THE LIABILITY STATED ABOVE. THESE WARRANTIES ARE IN LIEU OF ALL OTHER WARRANTIES EXPRESS OR IMPLIED, INCLUDING, BUT NOT LIMITED TO, THE IMPLIED WARRANTIES OF MERCHANTABILITY OR FITNESS FOR A PARTICULAR PURPOSE. SOME STATES DO NOT ALLOW THE EXCLUSION OF IMPLIED WARRANTIES OR THE LIMITATION OR EXCLUSION OF LIABILITY FOR INCIDENTAL OR CONSEQUENTIAL DAMAGES SO THE ABOVE EXCLUSIONS OR LIMITATIONS MAY NOT APPLY TO YOU. You are cautioned that the performance of this product can be affected by many factors, such as system configuration, software, application, and operator control of the system. It is your responsibility to determine suitability of this product for your purpose and application.

**Hope Industrial Systems, Inc.**

1325 Northmeadow Parkway  
Suite 100  
Roswell, GA 30076

[www.HISmonitors.com](http://www.HISmonitors.com)